

Air Wall

Data Sheet

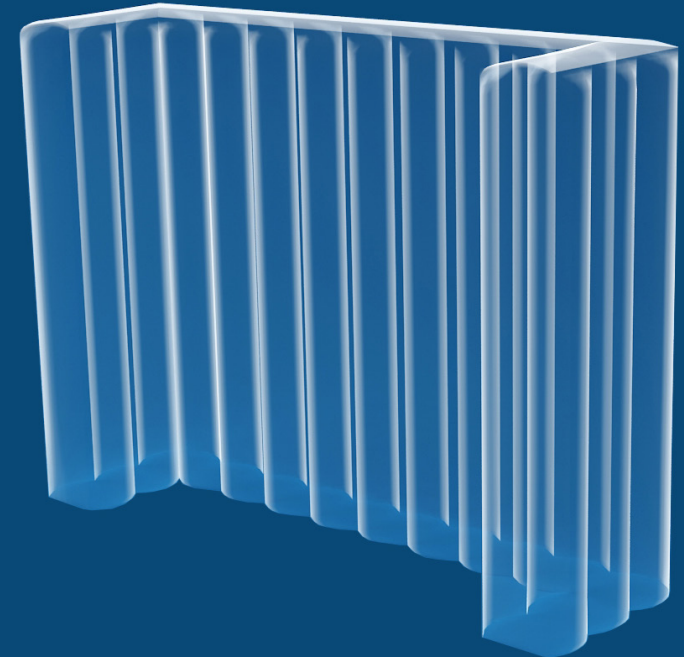
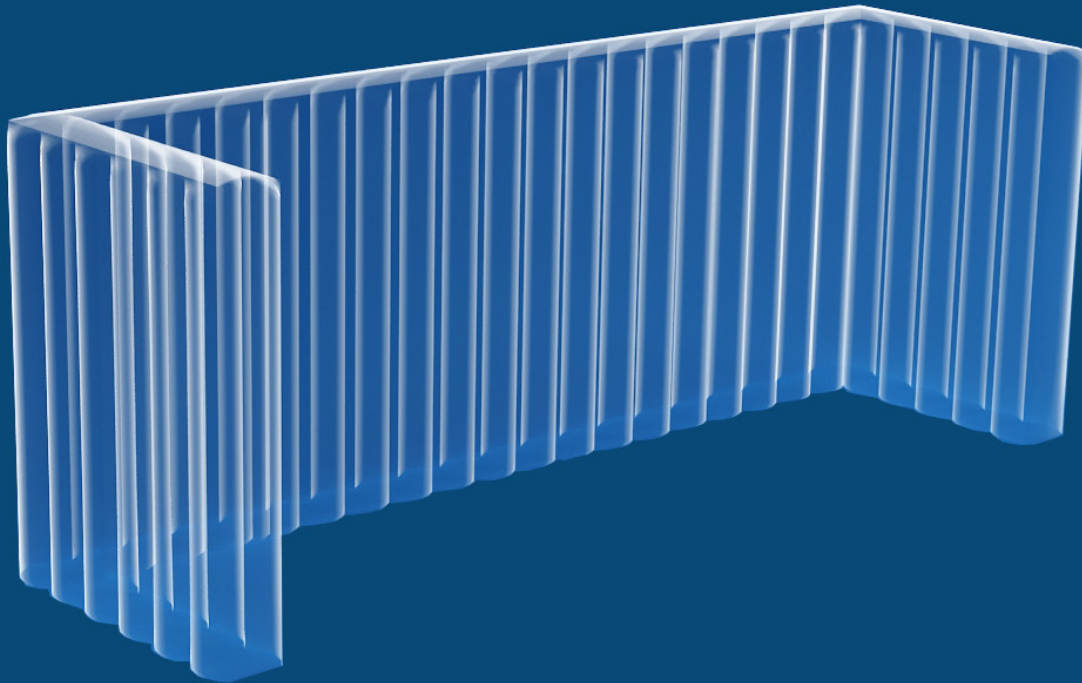

Product Variations

M3 Air is a brand new range of high performance, beautifully designed, and practical temporary event structures.

Light weight, easy to setup and remove each of the indoor range comes in its own storage bag and includes everything that is required for use. The fans provided are designed to be low noise. Creatively designed, M3 Air products are the worldwide leader in inflatable structures.

The M3 Air Wall range includes:

M3 Air Wall System

The wall system includes a range of flat event walls that easily zip together to offer small, medium and larger meeting areas. Creatively designed, easily and quickly installed an offering good sound insulation, the M3 Air event walls offer a fantastic temporary solution.

1. Full wall 2.4m long x 2.4m tall and 0.3m wide
2. Half wall 1.2m long x 2.4m tall and 0.3m wide
3. Zipped corner post 0.3m x 0.3m and 2.4m tall
4. Curved wall 2.4m x 2.4m and 0.3m wide

M3 Air Cubic Wall system

The cubic wall system provide instant spaces by offering space and stability, these walls are designed to be used either singular or multiples, either free standing or zipped together providing a multitude of layouts and creative spaces.

1. 3m long x 2.4m tall with a 0.9m return either end
2. 6m long x 2.4m tall with a 1.8m return either end
3. 9m long x 2.4m tall with a 2.7m return either end
4. 12m long x 2.4m tall with a 3.6m return either end

The M3 Air range of structures can be tailored to suit your event needs, we offer branding with options including direct print and replaceable printed covers.

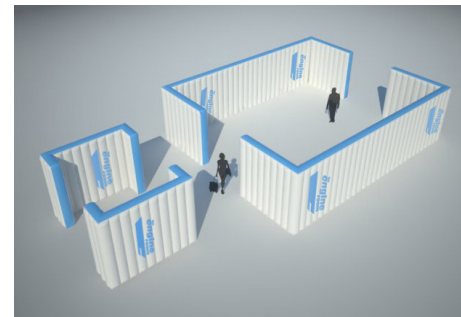
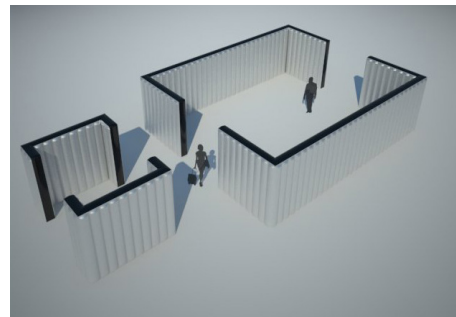

Air Wall Sizes

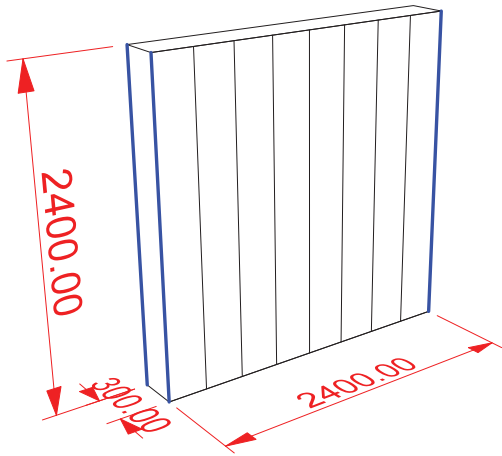

Full wall
(2.4m wide)

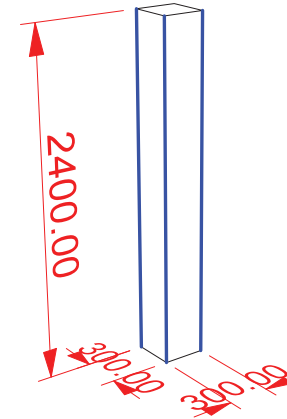

Corner Joint

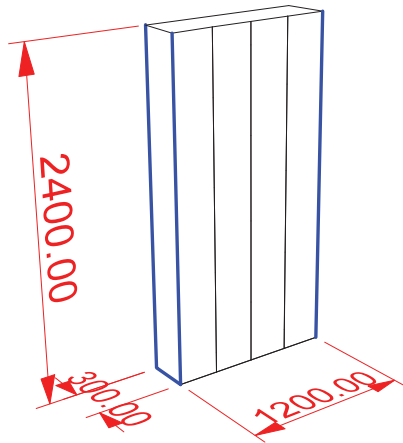

Half wall
(1.2m wide)

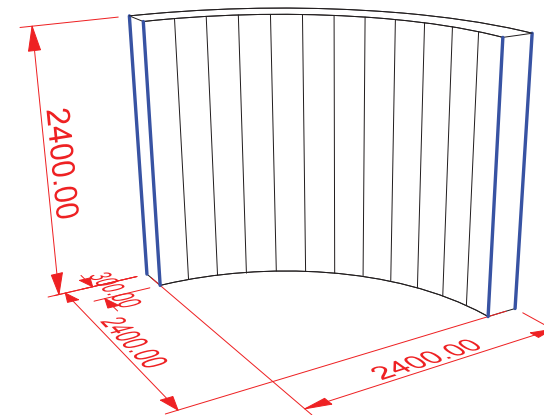

Curve wall
(2.4x2.4m)

Air Wall Sizes

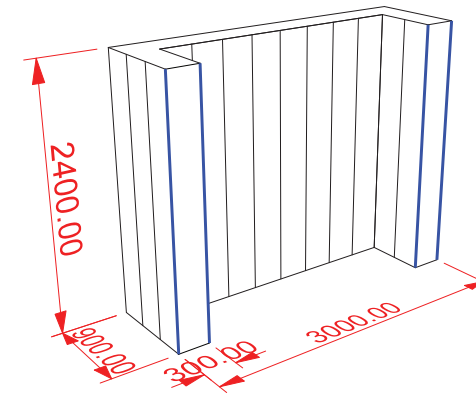
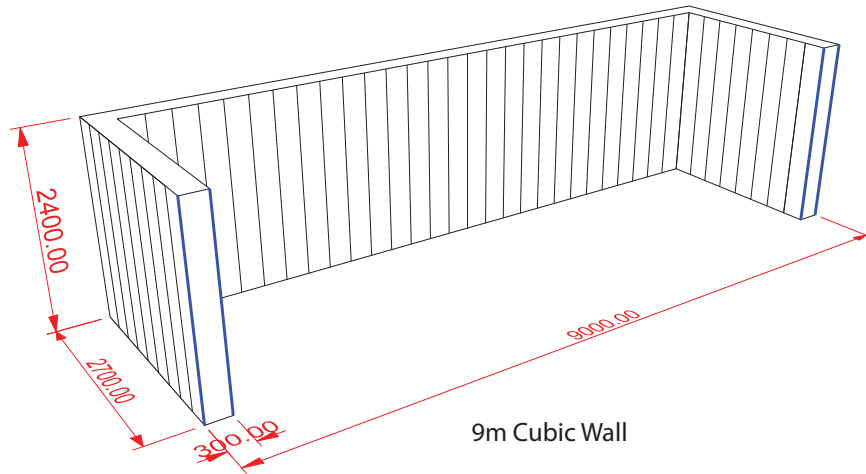
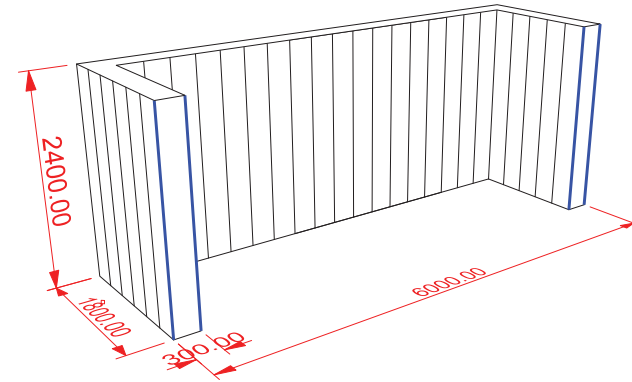
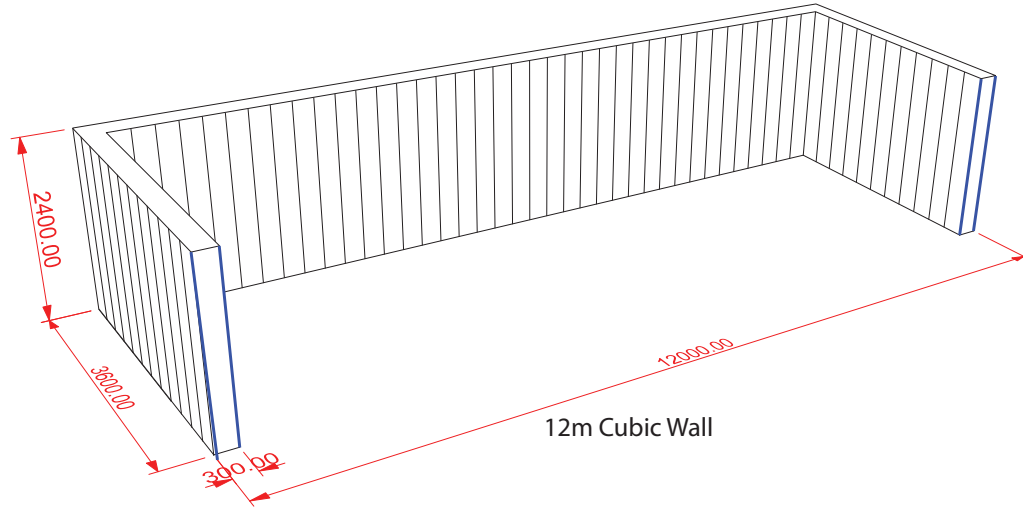

Product Accessories

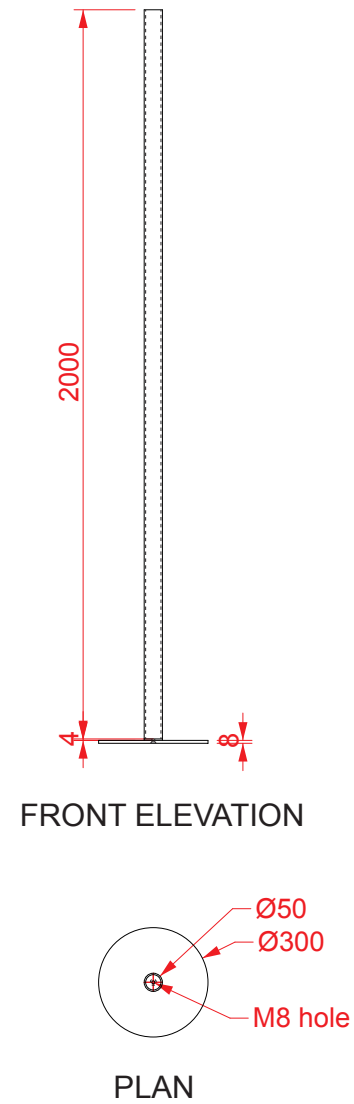
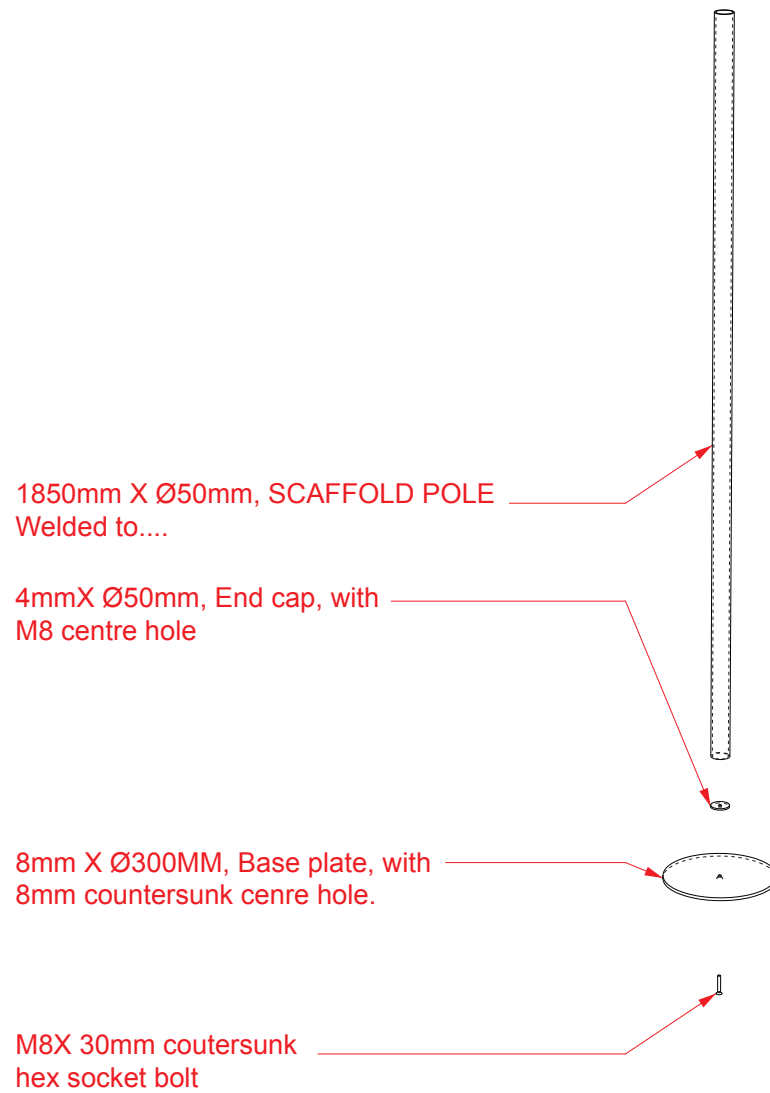

Product specification 1

UK PACKAGE

- 1 x Wall Structure, 1 x Packing Bag, 1 x Protection Ground Sheet. 1x 150W Fan.
- Corner Joint Structures sold without Bag, Fan or Groundsheet.

STRUCTURE

- Packed Size/Weight:**
- Full wall:- 500 x 400 x 300mm. 15kg (est.)
 - Half wall:- 400 x 300 x 200mm. 8kg (est.)
 - Curve wall:- 500 x 500 x 400mm. 18kg (est.)
 - Corner joint:- 200 x 200 x 100mm. 4kg (est.)

- Inflated Size:**
- Full wall:- W2.4 x D0.3 x H2.4m.
 - Half wall:- W1.2 x D0.3 x H2.4m.
 - Curve wall:- W2.4 x D2.4 x H2.4m.
 - Corner joint:- W0.3 x D0.3 x H2.4m.

- Fabrics:**
- PVC, rip stop nylon FR treated
- Colours:**
- Combinations of white/black/silver/frosted

Please Note: Information is correct at time of publication. Ingenious inflatables ltd accept no responsibility for variations in dimensions or weights. Ingenious inflatables ltd reserve the right to alter any dimensions or weights at any time without prior notice.

POWER & FANS

- Fans:**
- 1 x 150W fans
- Min Secure Power:**
- 0.5KVA
- Fan Weight:**
- 4kg per fan
- Fan Dimensions:**
- 285mm x 285mm x 150mm

Please Note: It is the responsibility of the client or site management to ensure that the power used for fans is secure and tested. The above power consumption is for fans only and covers no extra electrical items. No other item should be connected to the fan power lines. Ingenious inflatables ltd accepts no responsibility for damages to equipment or damages to inflatable structures, injuries to persons, or loss of earnings due to electrical power faults.

INSTALLATION & DERIG

- Crew:**
- 1 persons (min)
- Set Up Time:**
- From 30 mins
- Inflation Time:**
- 5 mins for structure when fixed
- Derig Time:**
- From 30 mins

PRODUCT ENHANCEMENTS

- Noise Reduction Equipment • Branding - Temporary / Permanent Banners/ Printed Covers
- Lighting • Trussing • Flooring
- Complete Interior Design and Production Service
- Custom Coloured Fabric • All Spares of Basic Package

Please Note: Refer to separate later page for more detail on product enhancement. Please note the above technical data can be effected by additional product enhancements. Ingenious inflatables ltd reserve the right to add or remove product enhancements from product range without prior notice.

Product specification 2

UK PACKAGE

- 1 x Wall Structure, 1 x Packing Bag, 1 x Protection Ground Sheet. 1x 150W Fan.
- Corner Joint Structures sold without Bag, Fan or Groundsheet.

STRUCTURE

- Packed Size/Weight:**
- 3m wall:- 500 x 300 x 300mm. 15kg (est.)
 - 6m wall:- 500 x 400 x 400mm. 18kg (est.)
 - 9m wall:- 600 x 500 x 400mm. 22kg (est.)
 - 12m wall:- 600 x 600 x 400mm. 26kg (est.)

- Inflated Size:**
- 3m wall:- W3 x D0.9 x H2.4m.
 - 6m wall:- W6 x D1.8 x H2.4m.
 - 9m wall:- W9 x D2.7 x H2.4m.
 - 12m wall:- W12 x D3.6 x H2.4m.

- Fabrics:**
- PVC, rip stop nylon FR treated
- Colours:**
- Combinations of white/black/silver/frosted

Please Note: Information is correct at time of publication. Ingenious inflatables ltd accept no responsibility for variations in dimensions or weights. Ingenious inflatables ltd reserve the right to alter any dimensions or weights at any time without prior notice.

POWER & FANS

- Fans:**
- 1 x 150W fans
- Min Secure Power:**
- 0.5KVA
- Fan Weight:**
- 4kg per fan
- Fan Dimensions:**
- 285mm x 285mm x 150mm

Please Note: It is the responsibility of the client or site management to ensure that the power used for fans is secure and tested. The above power consumption is for fans only and covers no extra electrical items. No other item should be connected to the fan power lines. Ingenious inflatables ltd accepts no responsibility for damages to equipment or damages to inflatable structures, injuries to persons, or loss of earnings due to electrical power faults.

INSTALLATION & DERIG

- Crew:**
- 1 persons (min)
- Set Up Time:**
- From 30 mins
- Inflation Time:**
- 5 mins for structure when fixed
- Derig Time:**
- From 30 mins

PRODUCT ENHANCEMENTS

- Noise Reduction Equipment • Branding - Temporary / Permanent Banners/ Printed Covers
- Lighting • Trussing • Flooring
- Complete Interior Design and Production Service
- Custom Coloured Fabric • All Spares of Basic Package

Please Note: Refer to separate later page for more detail on product enhancement. Please note the above technical data can be effected by additional product enhancements. Ingenious inflatables ltd reserve the right to add or remove product enhancements from product range without prior notice.

Product Enhancement

Branding

Branding can be applied permanently to any of the Inflatable structures as screen print or digital printing at the source of production.

Temporary branding can be added as vinyl or Dacron adhesive panels at any stage. Please note that not all artwork is suitable for printing on our structure range. It is advised sample artwork be supplied in an .eps format so we can advise the best solution. Full replaceable covers are available to the range. These can be branded and printed to ensure your structure matches your brand.

Bespoke colours and materials

All our structures are manufactured in ripstop nylon and reinforced PVC. As standard they are made in white and grey. Although a full colour range is available, this may alter lead times and costs.

Other materials are available and we are happy to discuss specific needs / projects and will advise on what we feel is the most appropriate solution. All fabrics are tested for performance of flammability for textiles used in the construction of marquees and similar textiles structures to standards: BS 7837:1996 / BS 5438:1989.

Lighting

As an optional extra we can provide internal LED lighting systems which will transform the look and feel of your inflatable structure. The ambient lighting effect can be either one colour change or mixed to produce your perfect environment.

Trussing

The M3 Air range of inflatable structures have been designed to be used as free standing products, trussing is not required to use them, however trussing can be added to enhance the environment. Full internal trussing systems are available to compliment your event structure. These can be used to hang PA equipment or other lighting options.

Doors & Closures

All of the M3 Air range comes complete with zip in/ out doors as standard. M3 Air also offers full aluminium double door systems. These provide fire safety openers and are fully lockable which provides increased security. The door systems are bespoke and made to be installed perfectly into our doorways.

Flooring

Flooring is available upon request and is offered to suit all event needs. We offer simple snap lock flooring. This offers light weight flooring and ideal for grass and concrete. It can be further enhanced by adding a finishing carpet.

We also offer aluminium / ply flooring which offers a professional and stable finish in any conditions. This type of flooring can take a number of finishers including carpet and wooden flooring.

Modularity

The entire M3 Air Range of Domes and Cubes can be joined together as the doorways are all standard. These can be jointed directly or by incorporating a space tunnel, these add an atmospheric walkway between the jointed structures and come in a range of lengths.

Transport

By its nature an inflatable structure packs down to considerably less than its inflated size. The largest of our range packs down to less than 2M³ which makes the structures ideal to store and use again. Each product will be supplied in its own storage bag and will be easily transported in an out of any venue.

Warranty

M3 Air offers a 12 month warranty on the manufacture process and materials if the user manual and install guides are followed. Due to the nature of weather and installation conditions, M3 Air reserves the right to carry out an onsite inspection and report which way the warranty will be met.